





Ray Profili
Rail Profile

1919

0,718 Kg/m

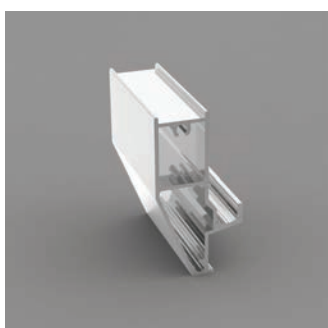
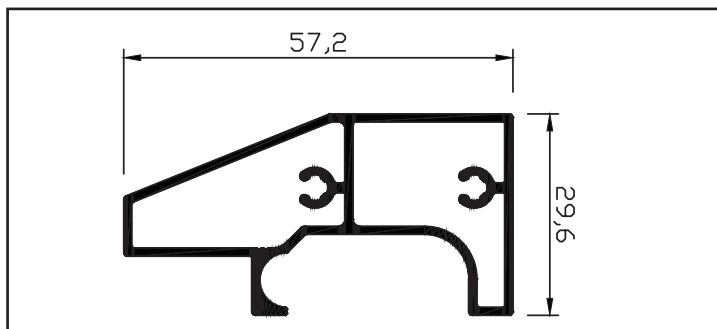

Ray Profili
Rail Profile

8677

0,667 Kg/m

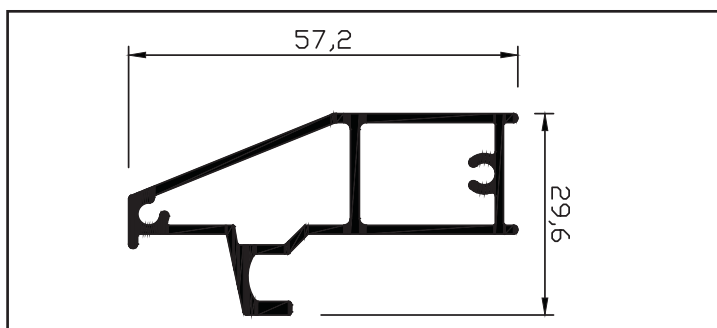

Cam Dikmesi
Glass holding profile

8678

0,419 Kg/m

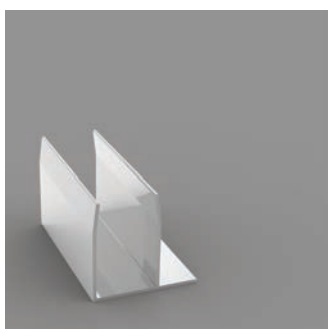
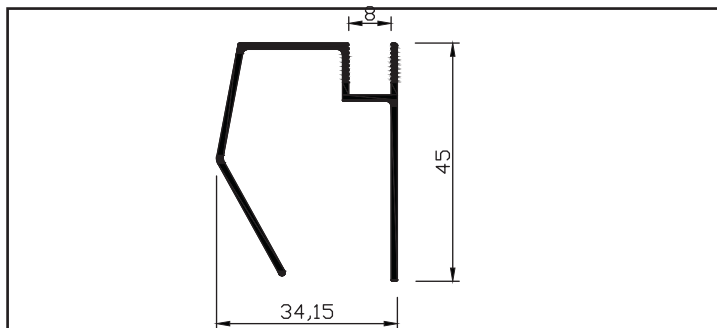

Duvar Dikmesi
Wall (side) Profile

1075

0,269 Kg/m

